

SB4101 User Guide

High-Speed Access to the Internet



Regulatory Information

Federal Communications Commission Radio and Television Interface Statement for a Class 'B' Device.

This equipment has been tested and found to comply with the limits for a Class B digital device, pursuant to part 15 of the FCC Rules. These limits are designed to provide reasonable protection against harmful interference in the residential installation. This equipment generates, uses and can radiate radio frequency energy and, if not installed and used in accordance with the instructions, may cause harmful interference to radio communications. However, there is no guarantee that interference will not occur in a particular installation.

If the equipment does cause harmful interference to radio or television reception, which can be determined by turning the equipment off and on, the user is encouraged

to try to correct the interference by one of the following measures:

- Increase the separation between the equipment and the affected receiver
- Connect the equipment on a circuit different from the one the receiver is on

You may find the following booklet, prepared by the Federal Communications Commission, helpful:

How to Identify and Resolve Radio-TV Interference Problems

**Stock No. 004-000-0342-4,
U.S. Government Printing Office
Washington, DC 20402**

Changes or modifications not expressly approved by the party responsible for compliance could void the user's authority to operate the equipment.



This product was FCC compliant under test conditions that included the use of the supplied cable between system components. To be in compliance with FCC regulation, the user must use this cable and install it properly.



Different types of cord sets may be used for connections to the main supply circuit. Use only a main line cord that complies with all applicable product safety requirements of the country of use.

Declaration of Conformity

According to 47CFR, Parts 2 and 15 for Class B Personal Computers and Peripherals; and/or CPU Boards and Power Supplies used with Class B Personal Computers, Motorola BCS, 6450 Sequence Drive, San Diego, CA 92121, 1-800-225-9446, declares under sole responsibility that the product identifies with 47CFR Part 2 and 15 of the FCC Rules as a Class B digital device.

Each product marketed is identical to the representative unit tested and found to be compliant with the standards. Records maintained continue to reflect the equipment being produced can be expected to be within the variation accepted, due to quantity production and testing on a statistical basis as required by 47CFR 2.909. Operation is subject to the following condition: This device must accept any interference received, including interference that may cause undesired operation. The above named party is responsible for ensuring that the equipment complies with the standards of 47CFR, Paragraph 15.101 to 15.109.

Canadian Compliance

This Class B digital apparatus meets all requirements of the Canadian Interference-Causing Equipment Regulations. Cet appareil numérique de la classe B respecte toutes les exigences du Règlement sur le matériel brouilleur du Canada.



Warning

TO PREVENT FIRE OR SHOCK HAZARD, DO NOT EXPOSE THIS APPLIANCE TO RAIN OR MOISTURE.

Caution

TO PREVENT ELECTRICAL SHOCK, DO NOT USE THIS PLUG WITH AN EXTENSION CORD, RECEPTACLE, OR OTHER OUTLET UNLESS THE BLADES CAN BE FULLY INSERTED TO PREVENT BLADE EXPOSURE.

THESE SERVICING INSTRUCTIONS ARE FOR USE BY QUALIFIED PERSONNEL ONLY. TO REDUCE THE

RISK OF ELECTRICAL SHOCK, DO NOT PERFORM ANY SERVICING OTHER THAN THAT CONTAINED IN THE INSTALLATION AND TROUBLESHOOTING INSTRUCTIONS UNLESS YOU ARE QUALIFIED TO DO SO. REFER ALL SERVICING TO QUALIFIED SERVICE PERSONNEL.

Repairs

If repair is necessary, return the Product (including all Software, components, documentation, and other contents of this Product package) together with proof of purchase to the place of purchase.



Copyright © 2001 by Motorola, Inc. All rights reserved.

No part of this publication may be reproduced in any form or by any means or used to make any derivative work (such as translation, transformation or adaptation) without written permission from Motorola, Inc.

Motorola, Inc. reserves the right to revise this publication and to make changes in content from time to time without obligation on the part of Motorola, Inc. to provide notification of such revision or change. Motorola, Inc. provides this guide without warranty of any kind, either implied or expressed, including, but not limited, to the implied warranties of merchantability and fitness for a particular purpose. Motorola, Inc. may make improvements or changes in the product(s) described in this manual at any time.

Motorola, the stylized M logo and SURFboard are registered trademarks and the SURFboard logo is a trademark of Motorola, Inc.

Macintosh is a registered trademark of Apple Corporation.

Microsoft and Windows are registered trademarks of Microsoft Corporation.

Netscape is a registered trademark of Netscape Communications Corporation.

QuickTime and QuickTime logo are trademarks of Apple Computer, Inc.

UNIX is a registered trademark of the Open Group.

Windows screens reproduced by permission of Microsoft Corporation.



Table of Contents

Introduction	1
Top and Front Panel	2
Rear Panel	4
Before You Begin	5
Precautions	6
System Requirements	7
Installation and Configuration	9
Installation and Configuration Tasks	9
Cabling and Startup for a Single User	10
Setting Up a USB Driver in Windows 98	13
Setting Up a USB Driver in Windows 2000 and Me	18
Configuring for TCP/IP in Windows 95, 98, and Me	23
Configuring for TCP/IP in Windows 2000	26
Verifying Your IP Address in Windows 95, 98, and Me	30
Verifying Your IP Address in Windows 2000	32
Cabling for Multiple Users	33

Table of Contents (cont'd)

Troubleshooting	35
Problems and Possible Solutions	35
Removing the SB4101 Device Listing from Windows 98	38
Removing the USB Driver from Windows 98	40
Removing the SB4101 Device Listing from Windows 2000 and Windows Me	42
Removing the USB Driver from Windows 2000 and Windows Me	46
Contact Us	48
Glossary	49
FAQs	51
Software License Agreement	54

Easier!*

Always on, always connected

Faster!**

Up to 100 times faster than a phone modem

Better!***

A great choice for Internet access

Just open your browser and surf!

Congratulations, you have a new state-of-the-art SB4101 cable modem! This high-speed, upgradeable modem enables you to connect your home or business computer to a DOCSIS-compliant data network. The SB4101 transmits and receives data at much higher speeds than traditional telephone or ISDN modems.

It provides high-speed access to the Internet and other online services.

A new Universal Serial Bus (USB) port is available for a single-user direct connection to USB-equipped computers. The standard Ethernet connection provides network service to single or multiple users.

Unlike a telephone modem, the SB4101 is always online. Just open your browser and surf.

** Unlike analog phone modems and ISDN, you're always on, always connected.*

*** Actual speed will vary. Many network and other factors affect download speeds.*

**** SURFboard is made by the company with over 50 years of cable TV expertise.*



Home



Print



Exit

▣ Top and Front Panel

The standby button suspends Internet service. The six front-panel lights provide information about power, communications, and errors.

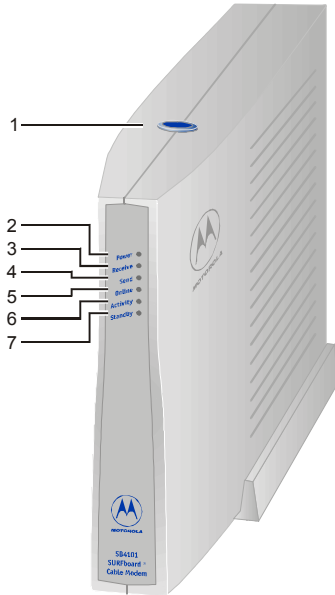

Item	Description
1 Standby Switch	Press this switch to disable the Ethernet and USB ports on the SB4101. No data is transmitted or received. Press this switch again to transmit and receive data. The Standby button offers added Internet security. When the standby switch is activated, all other lights turn off.
2 Power LED	When the light is flashing, startup diagnostics are being performed. A solid light indicates the SB4101 is powered on.
3 Receive LED	When the light is flashing, the SB4101 is scanning for a receive channel connection. A solid light indicates the channel connection is acquired.
4 Send LED	When the light is flashing, the SB4101 is scanning for the send channel connection. A solid light indicates the channel connection is acquired.



Home



Print



Exit

Top and Front Panel

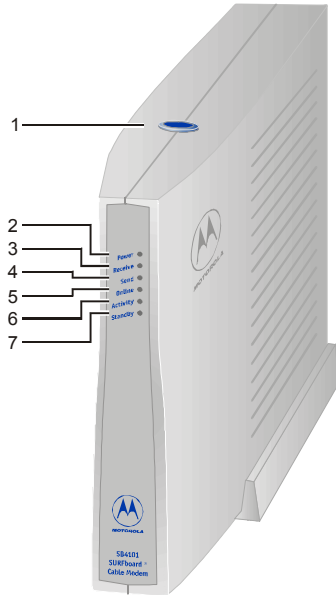

Item	Description
5 Online LED	When the light is flashing, the SB4101 is scanning for the network configuration server connection. A solid light indicates the network connection is acquired.
6 Activity	When the light is flashing, the SB4101 is transmitting or receiving data. When the light is off, the SB4101 is not transmitting or receiving data.
7 Standby	After pressing the Standby button on the top of the SB4101, the Standby light turns on indicating the Ethernet and USB ports are disabled (not receiving or transmitting data). The cable connection to the service provider remains active. Internet service is interrupted until the Standby button is pressed again. The Standby button offers added Internet security.



Home



Print



Exit

❖ Rear Panel

The rear panel provides cabling connectors, status lights, and the power receptacle.

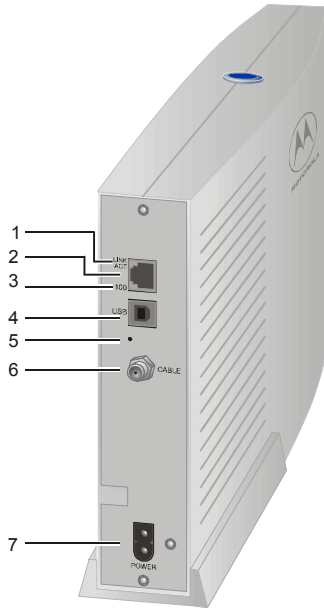

Item	Description
1 LINK/ACT	When the light is on, the Ethernet connection is available. A blinking light indicates data is being transferred.
2 	This port is the Ethernet connector that transfers data to and from your computer.
3 100	The light is on when a 100Base-T link is established and off when a 10Base-T link is established.
4 USB	This port provides a direct connection to USB equipped computers.
5 •	This is the recessed reset button.
6 CABLE	This port transfers data to and from the service provider.
7 POWER	This connector provides power to the SB4101.

[Home](#)[Print](#)[Exit](#)

❖ Before You Begin

Before you begin the installation, check that you have:

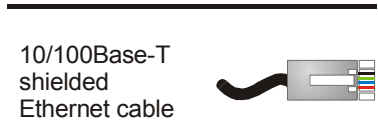

SB4101
User Guide
CD-ROM

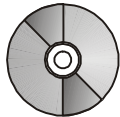

Item	Description
Power cord	Required for connecting the SB4101 to the AC electrical outlet.
One 10/100Base-T shielded Ethernet cable	Required for connecting to the Ethernet port.
One USB cable	Required for connecting to the USB port.
SB4101 User Guide CD-ROM	Contains the User Guide and USB drivers necessary for connecting to USB port.

You need to purchase a 75-ohm coaxial cable with F-type connectors for connecting your SB4101 to the nearest cable outlet. If you have a TV attached to the cable outlet, you may need a 5-900 MHz splitter to use both the TV and the SB4101. Both the coaxial cable and the RF splitter are readily available at consumer electronic stores.



You must call your service provider to activate your service. You need to provide the media access control (MAC) address. This address is found on the SB4101 bar code label marked HFC MAC ID on the rear panel. The address format is 00:20:40:xx:xx:xx or 00:04:db:xx:xx:xx.

⚠ Precautions

- Postpone SB4101 installation until there is no risk of thunderstorm or lightning activity in the area. Avoid damaging the SB4101 with static by touching the coaxial cable connector when it is attached to the earth grounded coaxial cable TV wall outlet. Always first touch the coaxial cable connector on the SB4101 when you are disconnecting or re-connecting your USB or Ethernet cable from the SB4101 or your PC.
- Do not block the ventilation holes on the sides of the cable modem to prevent overheating the SB4101.
- Do not open the SB4101 cable modem. Refer all service to your local service provider.
- Wipe the modem with a clean, dry cloth. Never use cleaning fluid or similar chemicals. Do not spray cleaners directly on the unit or use forced air to remove dust.



Home



Print



Exit

System Requirements Summary

- Service Provider
- Computer
- HTML Browser
- Ethernet card or SB4101 CD-ROM containing the USB software

■ System Requirements

You need the following to use the SB4101 with your computer system:

Service Provider

You must sign up with a data service provider for access to the Internet and other online services. You should ask your data service provider the following questions:

- Do you have any special system requirements?
- When can I begin to use my cable modem?
- Are there any files I need to download once I'm connected?
- Do I need a user name or password to access the Internet or use Email?

Computer

Your computer must be equipped with a USB or Ethernet port and Transmission Control Protocol/Internet Protocol (TCP/IP) to access the SB4101. The SB4101 is compatible with Microsoft®, Macintosh® and UNIX® operating systems. Computers using Windows® 95, UNIX, or Macintosh systems must use the Ethernet connection.



Home



Print



Exit

The Ethernet card must be installed before the SB4101. If it isn't, follow the installation instructions that came with your Ethernet card.

System Requirements

HTML Browser

Any standard HTML (web) browser works with the SB4101.

Ethernet Card or SB4101 CD-ROM Containing the USB Software

Any standard 10/100Base-T Ethernet card operates with the SB4101. This is not needed if connecting to the USB port. The Ethernet card must be installed before the SB4101. If it is not, follow the installation instructions included with your Ethernet card.

The USB connection is supported by Windows 98, Windows 2000, and Windows Me and requires special software to operate. The USB driver software files are on the CD-ROM supplied with your SB4101.

The USB drivers can be upgraded from the Internet. Check our website for information, <http://www.motorola.com/broadband>.

Your computer must be configured for TCP/IP and have an IP address for the SB4101 to operate. Your service provider furnishes the IP address.



Home



Print



Exit

Avoid damaging the SB4101
or your PC with static electricity.

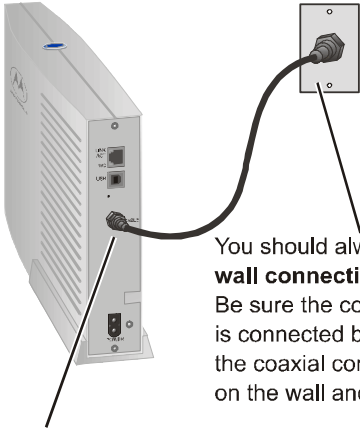

You should always make the **wall connection first**. Be sure the coaxial cable is connected between the coaxial connector on the wall and the SB4101.

To release any static charges, **touch the coaxial cable connector on the modem** before connecting or disconnecting the USB or Ethernet cables.

❖ Installation

Installation and Configuration Tasks

- Install cables
- Set up USB in Windows if you are using a USB port on your PC
- Configure TCP/IP
- Verify IP address

There are two sections for USB installation:

- Windows 98
- Windows 2000 and Windows Me



Home



Print



Exit

▣ Cabling and Startup for a Single User

You must allow 5 to 30 minutes to power up the first time because the SB4101 must find and lock on the appropriate channels for communications.

- 1 Be sure that your computer is on and the SB4101 is unplugged.
- 2 Connect the coaxial TV cable to the cable outlet or splitter and the other end to the SB4101 connector marked CABLE. Hand-tighten the connectors to avoid damaging them. You may need a 5-900 MHz splitter and an additional 75-ohm coaxial cable if you have a TV connected to the cable outlet.
- 3 Insert the SB4101 CD-ROM into your CD-ROM drive.
- 4 Plug the power cord into the SB4101 connector marked POWER and the other end to the electrical outlet.

Caution



Do not connect both Ethernet and USB cables to the same computer.

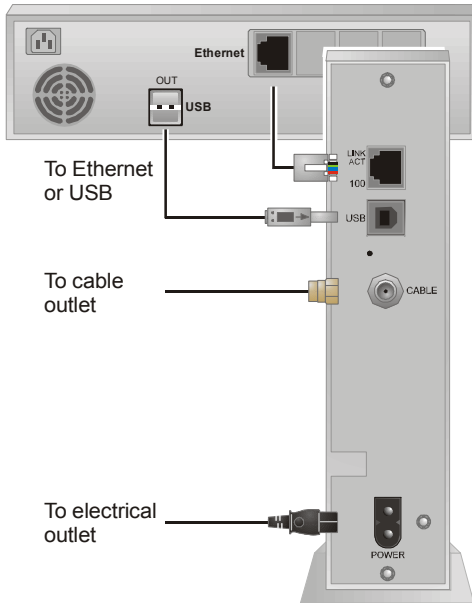

Home



Print



Exit

To turn on your SB4101, simply plug it in. It is not necessary to unplug it when not in use.

Cabling and Startup for a Single User

- 5 Check that the lights on the front of the SB4101 cycle through the following sequence:
 - Power flashes during a self-test. When the self-test is successfully complete, the light is solid green.
 - Receive flashes while the SB4101 scans for the receive channel. When the receive channel is locked, the light is solid green.
 - Send flashes while the SB4101 scans for the send channel. When the send channel is locked, the light is solid green.
 - Online flashes while the SB4101 is obtaining configuration information. When the configuration information is obtained, the light is solid green.



Home



Print



Exit

Cabling and Startup for a Single User

- 6 Connect your computer to the SB4101 using one of the following methods:

USB

Connect the USB cable to the SB4101 port marked USB and the other end to the USB port on the back of your computer.

For Windows 98 USB users, go to the next page.

For Windows 2000 and Windows Me USB users, go to page 18.

Ethernet

Connect the 10/100Base-T shielded Ethernet cable to the SB4101 Ethernet connector and the other end to the Ethernet jack on the back of your computer. For an Ethernet connection, skip over the USB instructions and go to “Configuring for TCP/IP” on page 23.

During normal operation, the Power, Receive, Send, and Online lights are on and the Activity light flashes when transferring data between the SB4101 and your computer.



Home



Print



Exit

➤ Setting Up a USB Driver in Windows 98

After plugging in the USB connector, the window on the left is displayed.

- 1 Click **Next**.

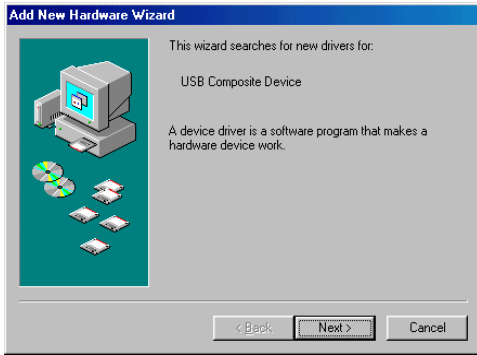

Setting Up a USB Driver in Windows 98

- 2 Be sure the text that reads “Search for the best driver for your device” is selected as displayed in the upper window on the left. Then, click **Next**, and the lower window on the left is displayed showing a location.

If your computer successfully locates the driver, proceed to step 4.

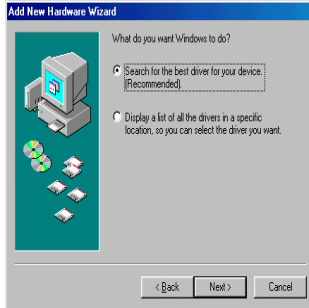

Home



Print



Exit

Setting Up a USB Driver in Windows 98

If your computer does not locate the driver, the previous window is displayed again. You should select “specify a location” and type in the location of your CD-ROM drive as shown in the upper window.

- 3 Click **Next**.
- 4 Select “The updated driver . . .” and then click **Next**.

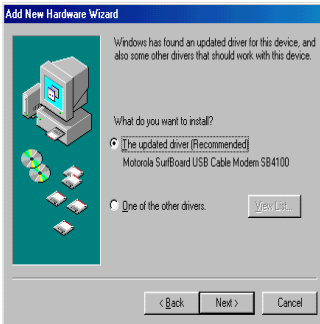
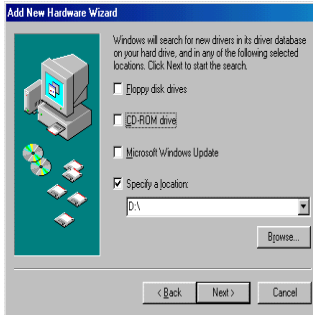

Setting Up a USB Driver in Windows 98

- 5 After the window on the left is displayed, click **Next**.

At this point, Windows 98 may need additional system files loaded to complete the installation. These files are located on your Windows 98 CD-ROM.

- 6 Be sure your Windows 98 CD-ROM is in the CD-ROM Drive and click **OK** to install System Files.

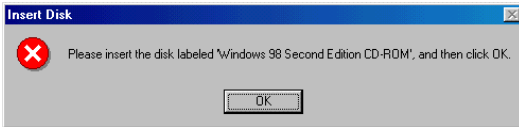
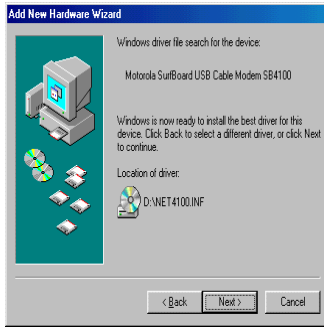

Home



Print



Exit

Setting Up a USB Driver in Windows 98



- 7 After all of the necessary Windows 98 files have been loaded, the upper window on the left is displayed confirming a successful installation.
- 8 Click **Finish** and the lower window is displayed.
- 9 Click **Yes** to restart your computer.

Refer to “Verifying Your IP Address in Windows 95, 98, and Me” on page 30 to verify your TCP/IP setup.

If you have any difficulties with the installation process, please follow the instructions for removing the SB4101 USB device from a Windows 98 computer that appear on page 38 in the *Troubleshooting* section.

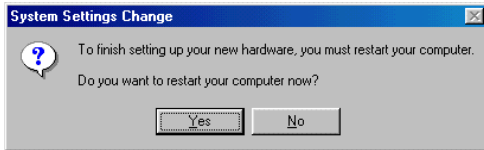

Home



Print



Exit

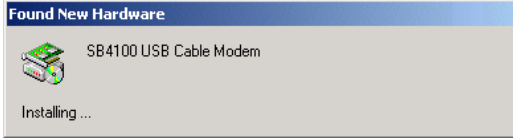

❖ Setting Up a USB Driver in Windows 2000 and Windows Me

- 1 After making the USB connection, the Found New Hardware window is displayed.

The SB4101 uses the same driver as the SB4100.



Home



Print



Exit

Setting Up a USB Driver in Windows 2000 and Windows Me

- 2 After several seconds, the Hardware Wizard window is displayed.
- 3 Click **Next**, and the lower window is displayed.
- 4 Be sure that the text that reads “Search for a suitable driver for my device” is selected and click **Next**.

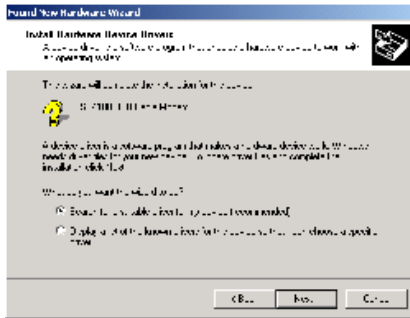
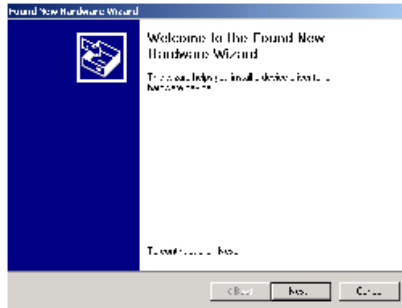

Home



Print



Exit



Setting Up a USB Driver in Windows 2000 and Windows Me

- 5 Be sure that the CD-ROM drive's box is the only one checked as illustrated in the upper window. Click **Next**, and the lower window is displayed.
- 6 Click **Next**.



Home



Print



Exit

Setting Up a USB Driver in Windows 2000 and Windows Me

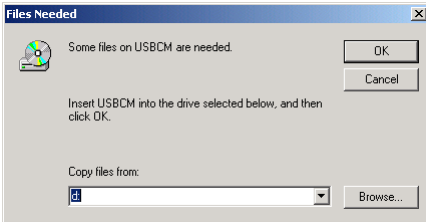
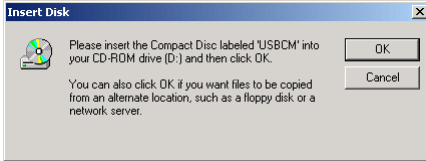

- 7 On the Insert Disk window, **D:** represents the CD-ROM drive. If D:\ is not the CD-ROM drive on your computer, enter the drive letter for your CD-ROM drive.
- 8 Click **OK** and the lower window on the left is displayed.
- 9 Select **Browse** and then locate a file called **Net4101.sys**. This file is located on the Motorola SB4101 CD-ROM root directory. Double-click the file called **Net4101.sys**.



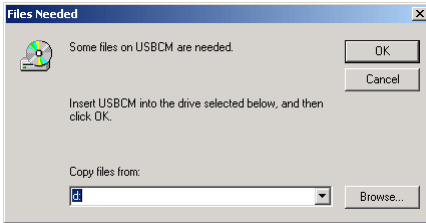

Setting Up a USB Driver in Windows 2000 and Windows Me

- 10 On the Files Needed window, click **OK** and the Found New Hardware Wizard window is displayed.
- 11 Click **Finish** to complete the installation.

If you have any difficulties with the installation process, please follow the instructions for removing the SB4101 USB device from a Windows 2000 or Windows Me computer that begin on page 42.

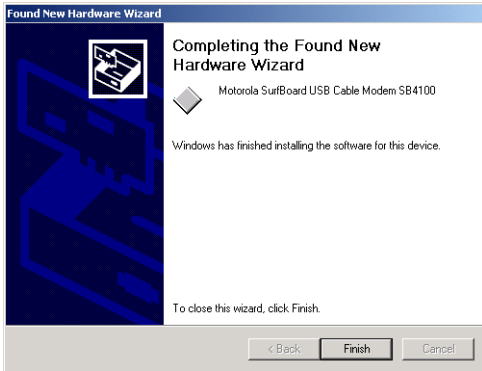

Home



Print



Exit

The SB4101 contains all necessary software. You don't need to configure the SB4101, but you must configure your computer for TCP/IP (software protocol developed for communication between computers) and check for an IP address. Your service provider may provide additional instructions for setting up your computer.

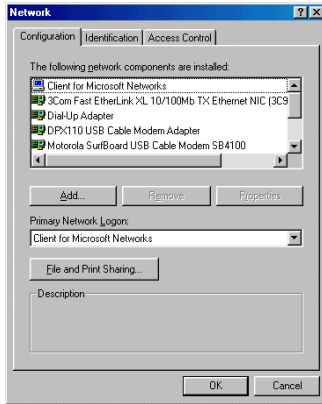

❖ Configuring for TCP/IP in Windows 95, 98, and Me

The following basic instructions are for Windows 95, 98 and Me. Windows 2000 configuration instructions begin on page 26. If you are using a different operating system, refer to your user guide.

- 1 On the Windows Desktop, click **Start**.
- 2 Select **Settings** and then **Control Panel** from the pop-up menus.
- 3 Double-click the **Network** icon on the Control Panel window.
- 4 Select the **Configuration** tab on the Network window.
- 5 Check to see if TCP/IP has been installed for the device being used (Ethernet card or USB). If TCP/IP is displayed in the list of network components, it is installed and you can proceed to step 10. If TCP/IP is not displayed on the list, continue with step 6.
- 6 Click **Add**.



Configuring for TCP/IP in Windows 95, 98, and ME

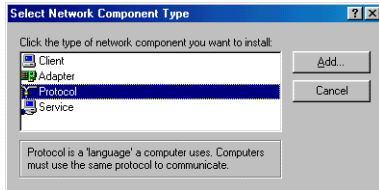

- 7 Double-click the **Protocol** option on Select Network Component Type window.
- 8 Click **Microsoft** in the Manufacturers section and then click **TCP/IP** in the Network Protocol section of Select Network Protocol window.
- 9 Click **OK**.

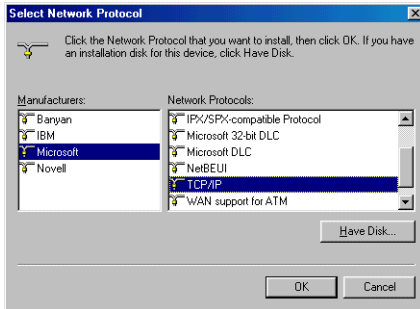

Home



Print



Exit

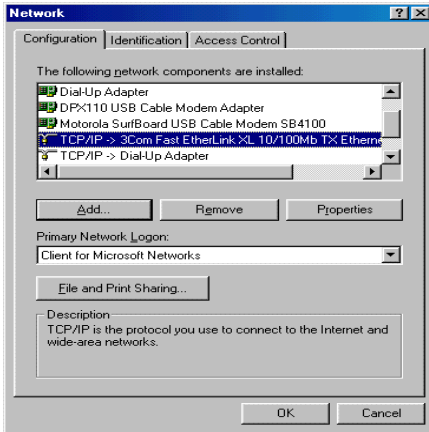

Configuring for TCP/IP in Windows 95, 98 and Me

- 10 Click **TCP/IP** on the Network window. If you have more than one TCP/IP entry, choose the one associated with the Ethernet card or USB device connected to the SB4101.
- 11 Click **Properties**.
- 12 Select the **IP Address** tab on the TCP/IP window.
- 13 Click **Obtain an IP address automatically**.
- 14 Click **OK** to accept the TCP/IP settings.
- 15 Click **OK** to close the Network window.
- 16 Click **OK** when prompted to restart your computer and then click **OK** again.



Home



Print



Exit

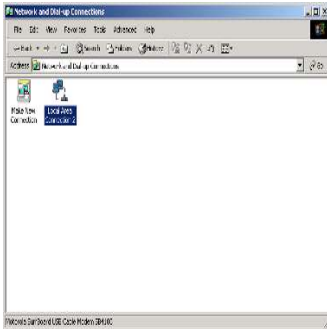
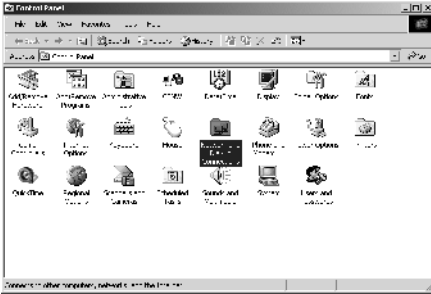

❖ Configuring for TCP/IP in Windows 2000

The following basic instructions are for Windows 2000 users. Windows 95, 98, and Me instructions begin on page 23. If you are using a different operating system, refer to your user guide.

- 1 On the Windows Desktop, click **Start**.
- 2 Select **Settings** and then **Control Panel** from the pop-up menus.
- 3 Double-click the **Network** and **Dial-up Connections** icon on the Control Panel window.
- 4 On the Network and Dial-up Connections window, click **Local Area Connection #**. The value of this number (#) varies from system to system, but usually is 2. The Local Area Connection # Status window is displayed as shown at the top of the next page.



Home



Print



Exit

Configuring for TCP/IP in Windows 2000

- 5 Click **Properties** and information similar to that shown in the lower window is displayed.
- 6 If Internet Protocol (TCP/IP) is displayed in the list of network components, TCP/IP is installed and you can proceed to step 10. If TCP/IP is not displayed on the list, continue with step 7 by clicking **Install**. This causes the Select Network Component Type window to be displayed as shown at the top of the next page.

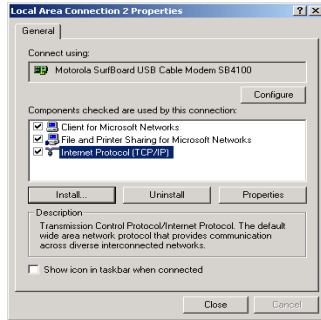
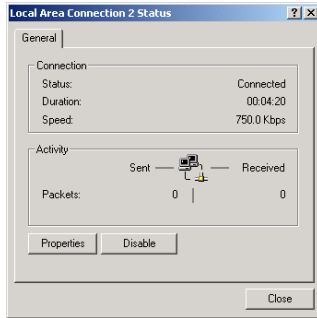

Home



Print



Exit

Configuring for TCP/IP in Windows 2000

- 7 Click **Protocol** on the **Select Network Component Type** window and then click **ADD**. The Select Network Protocol window is displayed similar to the example on the lower left of this page.
- 8 Click **Internet Protocol (TCP/IP)** in the Network Protocol section of Select Network Protocol window.
- 9 Click **OK** and the Local Area Connection # Properties window is re-displayed as shown at the top of the next page.

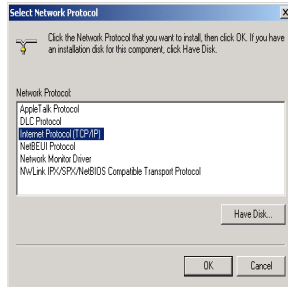
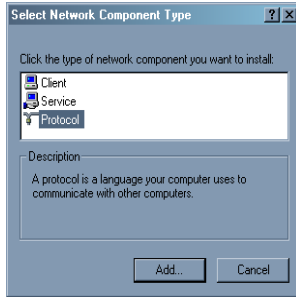

Home



Print



Exit

Configuring for TCP/IP in Windows 2000

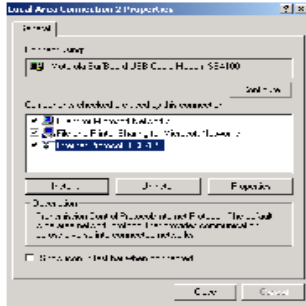

- 10 On the Local Area Connection # Properties window, make sure a check mark is in the box next to **Internet Protocol (TCP/IP)**. Click **Properties**. The Internet Protocol (TCP/IP) Properties window is displayed as shown on the lower left of this page. Make sure that “Obtain IP address automatically” and “Obtain DNS server address automatically” are selected.
- 11 Click **OK** to accept the TCP/IP settings.
- 12 Click **OK** to close the **Local Area Connection # Properties** window.
- 13 Click **OK** when prompted to restart your computer and then click **OK** again.

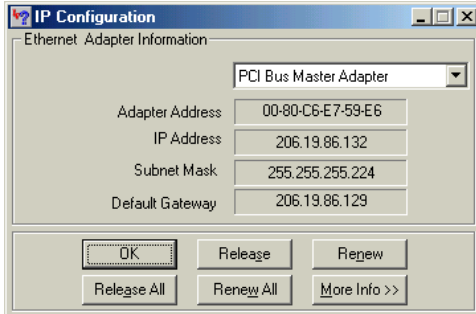

The values shown for Adapter Address, IP Address, Subnet Mask, and Default Gateway on your PC will be different than those shown in the example above.

Adapter Address	00-80-C6-E7-59-E6
IP Autoconfiguration Address	169.254.191.251

If autoconfiguration is displayed before IP Address in Windows 98, call your service provider.

❖ Verifying Your IP Address in Windows 95, 98, and Me

The following basic instructions are for Windows 95, 98, and Me. The instructions for verifying your IP address for Windows 2000 are found on the next page. For any other operating system, please refer to your specific operating system guide for IP address verification.

To check the IP address:

- 1 On the Windows Desktop, click **Start**.
- 2 Select **Run**.
- 3 Type **winipcfg.exe** and click **OK**. A window similar to the example shown on this page is displayed.
- 4 Select your adapter name—the Ethernet card or USB device.
- 5 Click **Renew**.
- 6 Click **OK** after the system displays an IP address.

If after performing this procedure your computer does not access the Internet, call your service provider. They will assist in your configuration.



Home



Print



Exit

❖ Verifying Your IP Address in Windows 2000

The following basic instructions are for Windows 2000. The instructions for verifying your IP address for Windows 95, and Me are found on the previous page. For any other operating system, please refer to your specific operating system guide for IP address verification.

To check the IP address:

- 1 On the Windows Desktop, click **Start**.
- 2 Select **Run**.
- 3 Type **cmd** and click **OK**. A window like the one on the upper left of this page is displayed.
- 4 Type **ipconfig** and press **ENTER** to display your IP configuration.
- 5 Type **exit** and press **ENTER** to return to the Windows operating system.

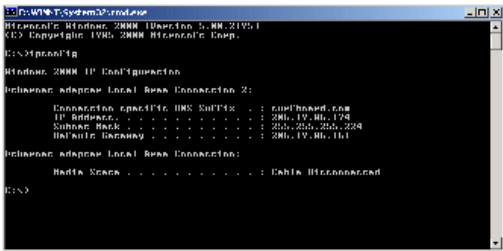
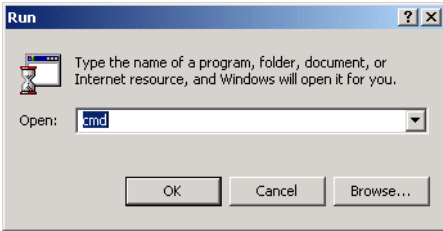

Verifying Your IP Address in Windows 2000

```
cmd
Microsoft Windows [Версия 5.00.2195.1
(c) Copyright 1980, 2000 Microsoft Corp.
C:\>ipconfig
Microsoft Windows [Версия 2000
Действие: адрес Local Area Connection 2:
    Подсеть: 192.168.1.0
    Маска подсети: 255.255.255.0
    Основной шлюз: 192.168.1.1
C:\>
```

Improper connections between your PC and the SB4101 and cable network problems are indicated when you receive an Autoconfiguration IP Address. An example is displayed on the upper left of this page. Check your cabling and whether you can see your regular cable-TV channels on your television.

After verifying your cable connections and proper operation of the cable-TV system by looking at the channels on your TV, you can attempt to renew your IP address.

To renew your IP address:

- 1 Type **ipconfig /renew** and then press **ENTER**. If a valid IP address is displayed, then Internet access should be available.
- 2 Type **exit** and then press **ENTER** to return to Windows.

If after performing this procedure your computer does not access the Internet, call your service provider. They will assist in your configuration.

```
cmd
Microsoft Windows [Версия 5.00.2195.1
(c) Copyright 1980, 2000 Microsoft Corp.
C:\>ipconfig /renew
Microsoft Windows [Версия 2000
Действие: адрес Local Area Connection 2:
    Подсеть: 192.168.1.0
    Маска подсети: 255.255.255.0
    Основной шлюз: 192.168.1.1
C:\>
```



Home



Print



Exit

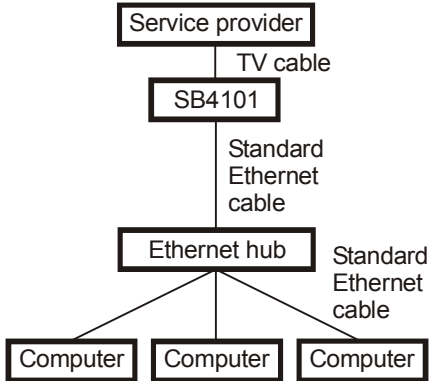

▣ Cabling for Multiple Users

Your service provider must configure your modem for multiple user service. Contact your service provider for availability and instructions.

The SB4101 supports many multiple user configurations. It can easily serve as a gateway to the Internet for up to 32 users.

Ethernet

Multiple users must be connected to an Ethernet hub, which should be attached to the SB4101.

Caution



Do not connect both the Ethernet and USB cables to the same computer.

Multiple computers cannot be connected to the SB4101 through the USB port.



Home



Print



Exit

Cabling for Multiple Users

Multiple user configurations can include Ethernet and USB connections.

Ethernet and USB

For two users on individual computers, connect the USB and Ethernet ports directly to the SB4101.

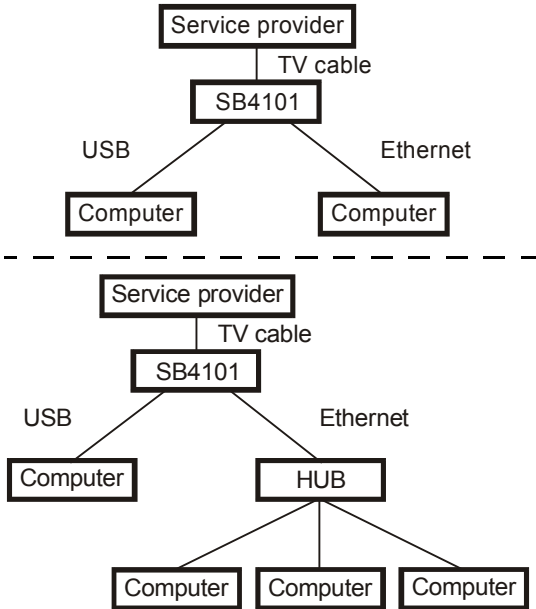

Multiple users are supported with a single user attached to the USB port and the remaining (up to 31) users connected to the Ethernet hub.

Caution



Do not connect both the Ethernet and USB cables to the same computer.



Home



Print



Exit

❖ Troubleshooting

This information helps you solve a problem quickly. Before calling your service provider, try pressing the reset button on the rear panel. Resetting the SB4101 may take 5 to 30 minutes. Your service provider may need to know the status of the front-panel lights.

Problem

Green POWER light is off

Possible Solutions

- Check that the power cord is properly plugged into the wall outlet and the rear panel of the SB4101.
- Check that the electrical outlet is working.
- Press the **Standby** button to reconnect Internet service.
- Press the **Reset** button.
- Call your service provider.



Troubleshooting

Problem

Cannot send or receive data

Possible Solutions

- Check the lights on the front panel. Note the first light from top to bottom that is off. This light indicates where the error occurred. If the first light that is off is:

Light	Turns off under the following error condition(s):
Receive	During startup, the receive channel is not acquired. During normal operation, the receive channel is lost.
Send	During startup, the send channel is not acquired. During normal operation, the send channel is lost.
Online	During startup, the IP registration was not successful. During normal operations, the IP registration is lost.
Power	The modem may be in standby mode, press the Standby button.

- Check that your TV is working if you have cable, and that you have a clear TV picture. If you are not receiving your regular TV channels, your data service will not function.



Home



Print



Exit

Troubleshooting

Problem

Cannot send or receive data (cont'd)

Cannot view User Guide CD video

Operating System problems related to unsuccessful installation of the SB4101 USB driver

Possible Solutions

- Check the coaxial cable at the modem and wall outlet and hand-tighten if necessary.
- Check the IP address (follow the steps in Verifying Your IP Address on page 30); call your service provider if you need an IP address.
- Check that the USB or Ethernet cable is attached at the modem and your computer.
- Press the Standby button to reconnect Internet service.
- Check that Acrobat Reader 4.0 is installed and selected.
- Remove the USB driver using the instructions for a Windows 98 or Windows 2000/Windows Me computer that appear on the following pages.



Home



Print



Exit

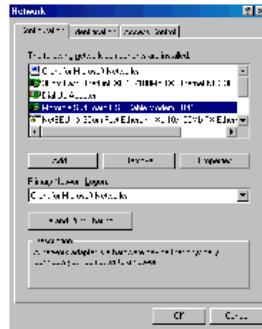
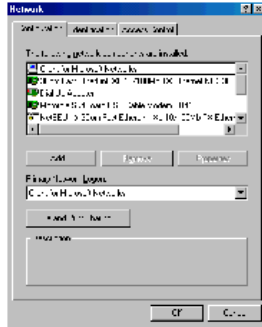

❖ Removing the SB4101 Device Listing from Windows 98

- 1 On your Windows Desktop, right click the **Network Neighborhood** icon and select **Properties**. The Network window is displayed.
- 2 Highlight the text that reads “Motorola SurfBoard USB Cable Modem SB4101,” as illustrated in the lower window.

This procedure does not remove the USB driver from your system, it only removes the device listing from your system.



Removing the SB4101 Device Listing from Windows 98

- 3 Click **Remove** and the Network Dialogue window no longer shows the “Motorola SurfBoard USB Cable Modem” in the list.
- 4 Click **OK**, and the System Settings Change window is displayed.
- 5 Click **No**.

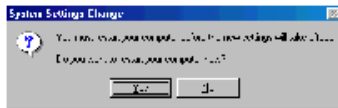
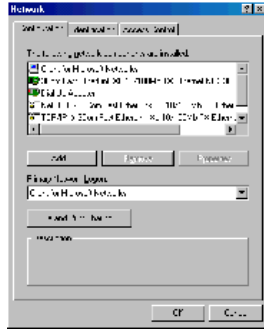

❖ Removing the USB Driver from Windows 98

You now need to start Windows Explorer. Start Explorer by clicking **Start** and then selecting **Run**. In the Run window, type **explorer** and then click **OK**. The Exploring window is displayed as shown on the left.

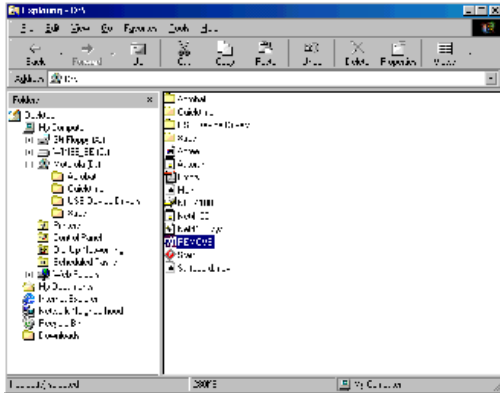

- 1 Be sure that the USB cable has been removed from your PC or SB4101 cable modem.
- 2 Select your CD-ROM drive. Run the Remove utility from the Motorola SB4101 CD-ROM by double clicking the Remove icon.

The SB4101 uses the same driver as the SB4100.



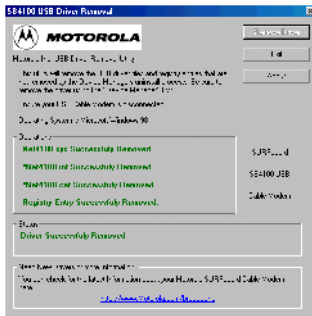
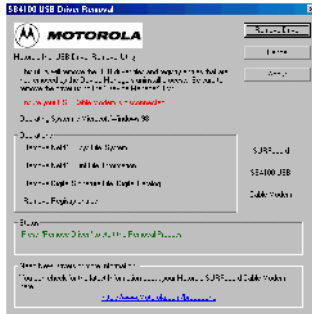

Removing the USB Driver from Windows 98

The SB4101 USB Driver Removal windows are displayed on this page.

3 Click **Remove Driver**.

4 The removal of the SB4101 USB is now complete.

You may get various messages in this step, depending on the previous installation. The status messages you receive are informational only.

5 After you have removed the USB device, repeat the Windows 98 USB Installation procedure to reinstall the SB4101 with a USB device.

If you have problems, please call us toll-free 1-877-466-8646.



Home



Print



Exit

❖ Removing the SB4101 Device Listing from Windows 2000 and Windows Me

- 1 From your Windows 2000 or Windows Me desktop, click **Start**.
- 2 Click **Settings**.
- 3 Click the **Control Panel** icon and the window on the left is displayed.
- 4 Double-click the **Add/Remove Hardware** icon. This action starts the Add/Remove Hardware Wizard as illustrated in the upper window on the next page.

This procedure does not remove the USB driver from your system, it only removes the device listing from your system.

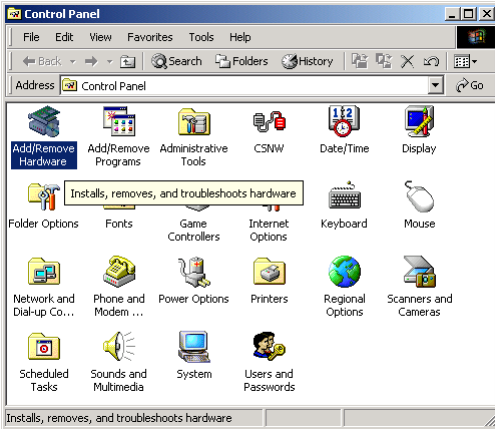

Home



Print



Exit

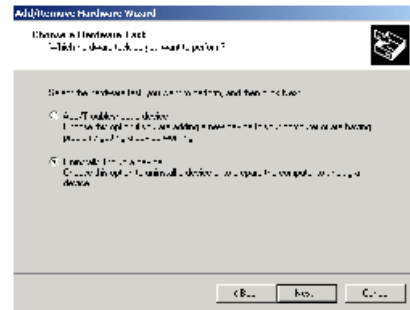
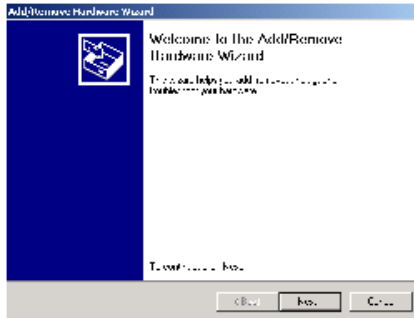

Removing the SB4101 Device Listing from Windows 2000 and Windows Me

- 5 Click **Next** to continue, and the lower window on the left is displayed.
- 6 Select Uninstall/Unplug a device and click **Next**.



Home



Print



Exit

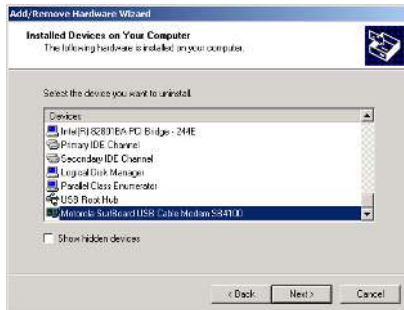
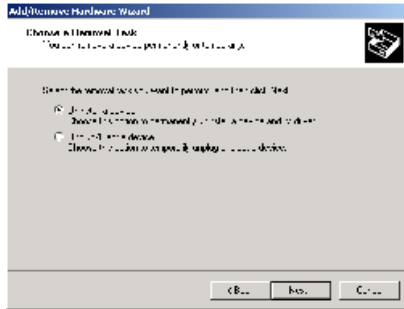

Removing the SB4101 Device Listing from Windows 2000 and Windows Me

- 7 On the upper window, select Uninstall a device and click **Next**.
- 8 If you unplugged the USB cable from the SB4101 (and saw the “Unsafe Removal of a Device” window), then the SB4101 will probably not be listed as illustrated in the lower window.

If the device is not listed, then click **Cancel**. If it is listed, highlight the SB4101 and click **Next**.



Home



Print



Exit

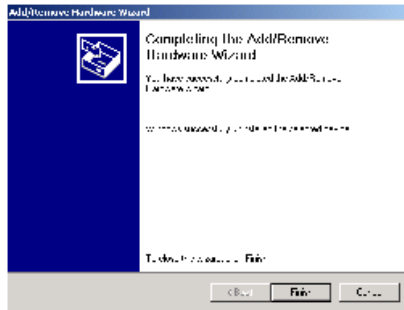
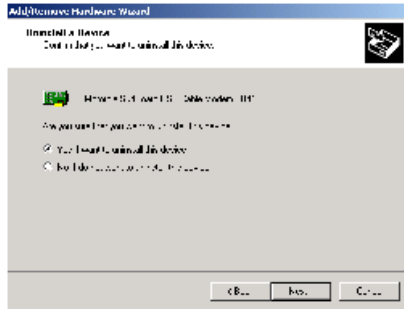

Removing the SB4101 Device Listing from Windows 2000 and Windows Me

- 9 On the upper window on the left, select “Yes, I want to uninstall this device” and click **Next**.
- 10 On the lower window, click **Finish**.
- 11 Close the Control Panel Window.



Home



Print



Exit

❖ Removing the USB Driver from Windows 2000 and Windows Me

- 1 Start Windows Explorer. Click **Start** and then select Run.
- 2 In the Run window, type **explorer** and then click **OK**.
- 3 Double-click **My Computer**.
- 4 Double-click on the **Motorola (D:)** CD Icon.
- 5 Double-click the **REMOVE OUT USB** Icon, as illustrated in the window on the left.

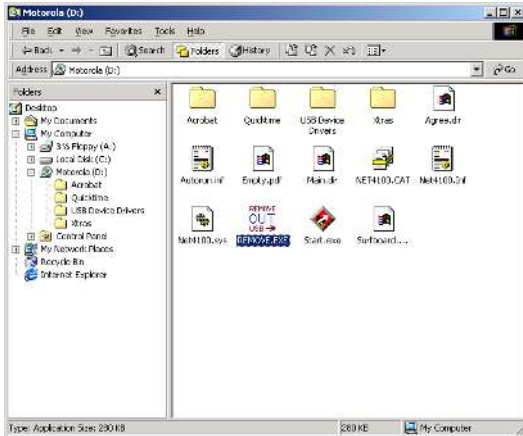

The SB4101 uses the same driver as the SB4100.



Home



Print



Exit

Removing the USB Driver from Windows 2000 and Windows Me

- 6 The window on the left is displayed. *Be sure that the USB Cable Modem is disconnected.* Click **Remove Driver**.

Depending upon how the device was removed early on in the process, all of the files may not be shown as Successfully Removed and some of the files may be displayed as Not Found. If a file displays a status of Not Found, Windows 2000 or Windows Me removed the file during the Add/Remove Hardware Wizard portion of this de-installation procedure.

- 7 Once you have removed the USB device, repeat the Windows 2000 USB Installation procedure to reinstall the SB4101 with a USB device.

If you have problems, please call us toll-free at 1-877-466-8646.

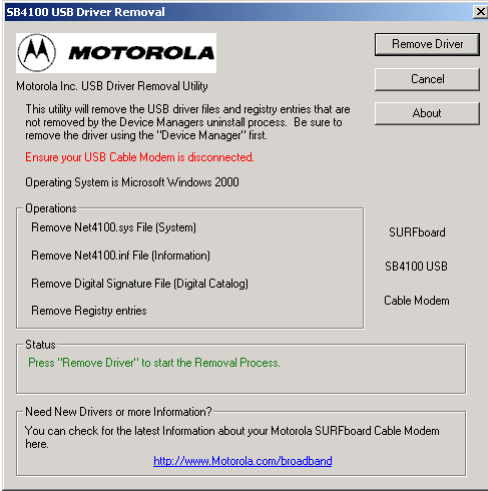

Home



Print



Exit

Contact Us

For technical support of your cable modem, call Motorola: 1-877-466-8646 (USA only).

For questions about your Internet service or connection, call your cable service provider.

For Motorola consumer cable products, education, and support:
<http://www.motorola.com/broadband>

For Motorola cable modem sales, customer service, technical support, and warranty claims, call toll-free: 1-877-466-8646 (USA only).



Glossary

Coaxial cable (coax)

A type of wire that consists of a center wire surrounded by insulation and then a grounded shield of braided wire. The shield minimizes electrical and radio frequency interference. The coaxial cable is the primary type of cabling used by the cable television industry and is also widely used for computer networks.

DOCSIS

The Data-Over-Cable Service Interface Specifications defines interface standards for cable modems and supporting equipment.

Expansion slot

An opening in a computer where a circuit board can be inserted to add new capabilities to the computer. Expansion slots for PCs come in half- and full-size. Half-size slots are also called 8-bit slots, and full-size slots are called 16-bit slots. PCI expansion slots are always full-size and connect directly to the PCI bus.

F-type connector

A connector used in the cable television industry that connects coaxial cable to equipment.

IP address

An identifier for a computer or device on a TCP/IP network. Networks using the TCP/IP protocol route messages based on the IP address of the destination.

MAC address

Media Access Control address. A hardware address that uniquely identifies each node of a network. The MAC address is used to forward information through a network to its final destination.



Home



Print



Exit

Glossary

MHz	Mega Hertz. A measure of radio frequency - millions of cycles per second. One MHz represents one million cycles per second.
PCI	Peripheral Component Interconnect. Most PCs today include a PCI bus in addition to a more general ISA expansion bus.
Splitter	A splitter is a device that divides the signal power from an input cable equally between two or more signals, each carrying a selected frequency range.
TCP/IP	Transmission Control Protocol/Internet Protocol. A set of protocols that provides the standards and rules for controlling and managing communications between networks.
VGA	Video Graphics Array. A graphics display system for PCs. All PCs made today support VGA, and possibly some other more advanced standard.



Home



Print



Exit

 **FAQs**

Got a question? We've put together a list of questions customers frequently ask.

Q What is high-speed cable Internet access?

A Cable Internet access uses cable television wires instead of telephone lines to tap into the information on the Internet. It's extremely fast and affordable, and it doesn't tie up phone lines for incoming or outgoing calls and faxes.

Q How fast are cable modems?

A Cable modems offer Internet access at speeds up to 50 times faster* than a traditional phone modem. A cable modem user can experience speeds of over 1,000 Kbps. Due to network conditions, such as traffic and the speed of the site you're visiting, actual download rates may vary.

Q Can I still watch cable TV while I'm using my cable modem?

A Yes, cable television lines are capable of handling the cable TV signal as well as sending and receiving information on the Internet - at the same time.

* Actual speed will vary. Many network and other factors affect download speeds.



FAQs

Q What is DOCSIS?

A DOCSIS is the industry standard for cable Internet access. This standard is intended to ensure that all DOCSIS cable modems interface with all DOCSIS-compliant cable systems. Motorola's SB4101 cable modem is DOCSIS compliant.

Q If I have a cable modem, can I still use my old 28.8 Kbps or 56 Kbps modem?

A Sure! Although once you've experienced the speed of cable Internet access, you'll never again want to wait for traditional dial up services.

Q I have more than one computer. Do I need more than one computer modem?

A No, not if your computers are connected via a network. The SB4101 is capable of supporting current Internet Connection Sharing technologies. Internet Connection Sharing software enables the user to connect more PCs to the Internet by using the PC containing the SB4101 as a gateway.

Q Do I need to change my Internet Service Provider (ISP)?

A Currently most Internet Service Providers are not set up to handle cable Internet access. Check with your local cable company for your specific information.



FAQs

Q Do I need to subscribe to cable TV to get cable Internet access?

A No, but you will need to subscribe to cable Internet service. Some systems require that you subscribe to basic service before you can get Internet access and/or offer a discount when you use your own cable modem. Check with your local cable company for specific information.

Q What does the SB4101 limited warranty cover?

A The standard coverage for an SB4101 is a 2-year limited warranty.

Q What type of technical support is available?

A For questions about your Internet service or connection, call your cable service provider. If you have problems with your Motorola broadband products, you can call us toll-free at 1-877-466-8646 (USA only).

Q What do I do if my modem stops working?

A Refer to the *Troubleshooting* section of this User Guide. It has quick tips for diagnosing problems, as well as simple solutions. If you continue to have problems, call your cable service provider. You can call us toll-free at 1-877-466-8646 (USA only).



Home



Print



Exit

✚ Software License

MOTOROLA SOFTWARE
(U.S.A. and Canada)
MOTOROLA, INC.
Broadband Communications Sector
Cable Modem Division
101 Tournament Drive
Horsham, PA 19044

IMPORTANT: PLEASE READ THIS SOFTWARE LICENSE (“LICENSE”) CAREFULLY BEFORE YOU INSTALL, DOWNLOAD OR USE ANY APPLICATION AND/OR USB DRIVER SOFTWARE AND RELATED DOCUMENTATION PROVIDED WITH MOTOROLA'S CABLE MODEM PRODUCT (THE “CABLE MODEM”). BY USING THE CABLE MODEM AND/OR INSTALLING, DOWNLOADING OR USING ANY OF THE AFOREMENTIONED SOFTWARE (TOGETHER WITH CABLE MODEM FIRMWARE, THE “SOFTWARE”), YOU INDICATE YOUR ACCEPTANCE OF EACH OF THE TERMS OF THIS LICENSE. UPON ACCEPTANCE, THIS LICENSE WILL BE A LEGALLY BINDING AGREEMENT BETWEEN YOU AND MOTOROLA. THE TERMS OF THIS LICENSE APPLY TO YOU AND TO ANY SUBSEQUENT USER OF THIS SOFTWARE.

IF YOU DO NOT AGREE TO ALL OF THE TERMS OF THIS LICENSE (I) DO NOT INSTALL OR USE THE SOFTWARE AND (II) RETURN THE CABLE MODEM AND THE SOFTWARE, INCLUDING ALL COMPONENTS, DOCUMENTATION AND ANY OTHER MATERIALS PROVIDED WITH THE CABLE MODEM, TO THE PLACE OF PURCHASE FOR A FULL REFUND.



Home



Print



Exit

Software License

The Software includes associated media, any printed materials, and any “on-line” or electronic documentation. Software provided by third parties may be subject to separate end-user license agreements from the manufacturers of such Software.

The Software is never sold. Motorola licenses the Software to the original customer and to any subsequent licensee for personal use only on the terms of this License. Motorola and its 3rd party licensors retain the ownership of the Software.

You may:

USE the Software only in connection with the operation of the Cable Modem.

TRANSFER the Software (including all component parts and printed materials) permanently to another person, but only if the person agrees to accept all of the terms of this License. If you transfer the Software, you must at the same time transfer the Cable Modem and all copies of the Software (if applicable) to the same person or destroy any copies not transferred.

TERMINATE this License by destroying the original and all copies of the Software (if applicable) in whatever form.



Home



Print



Exit

Software License

You may not:

(1) Loan, distribute, rent, lease, give, sublicense or otherwise transfer the Software, in whole or in part, to any other person, except as permitted under the TRANSFER paragraph above. (2) Copy or translate the User Guide included with the Software, other than for personal use. (3) Copy, alter, translate, decompile, disassemble or reverse engineer the Software, including but not limited to, modifying the Software to make it operate on non-compatible hardware. (4) Remove, alter or cause not to be displayed, any copyright notices or startup message contained in the Software programs or documentation. (5) Export the Software or the Cable Modem components in violation of any United States export laws.

The Software is not designed or intended for use in on-line control of aircraft, air traffic, aircraft navigation or aircraft communications; or in design, construction, operation or maintenance of any nuclear facility. MOTOROLA AND ITS 3RD PARTY LICENSORS DISCLAIM ANY EXPRESS OR IMPLIED WARRANTY OF FITNESS FOR SUCH USES. YOU REPRESENT AND WARRANT THAT YOU SHALL NOT USE THE SOFTWARE FOR SUCH PURPOSES.



Home



Print



Exit

Software License

Title to this Software, including the ownership of all copyrights, mask work rights, patents, trademarks and all other intellectual property rights subsisting in the foregoing, and all adaptations to and modifications of the foregoing shall at all times remain with Motorola and its 3rd party licensors. Motorola retains all rights not expressly licensed under this License. The Software, including any images, graphics, photographs, animation, video, audio, music and text incorporated therein is owned by Motorola or its 3rd party licensors and is protected by United States copyright laws and international treaty provisions. Except as otherwise expressly provided in this License, the copying, reproduction, distribution or preparation of derivative works of the Software, any portion of the Cable Modem or the documentation is strictly prohibited by such laws and treaty provisions. Nothing in this License constitutes a waiver of Motorola's rights under United States copyright law.

This License and your rights regarding any matter it addresses are governed by the laws of the Commonwealth of Pennsylvania, without reference to conflict of laws principles. THIS LICENSE SHALL TERMINATE AUTOMATICALLY if you fail to comply with the terms of this License.

Motorola is not responsible for any third party software provided as a bundled application, or otherwise, with the Software.

U.S. GOVERNMENT RESTRICTED RIGHTS

The Software, Cable Modem and documentation is provided with RESTRICTED RIGHTS. The use, duplication or disclosure by the Government is subject to restrictions as set forth in subdivision ©(1)(ii) of The Rights in Technical Data and Computer Software clause at 52.227-7013. The contractor/manufacturer is Motorola, Inc., Broadband Communications Sector, 101 Tournament Drive, Horsham, PA 19044.

[Home](#)[Print](#)[Exit](#)

